

Color    

Features

1. 4 in 1 with red, blue, green and warm white
2. Flexible FPC for proper bending
3. Cuttable every 50mm [1.97 inch]
4. IP67 & IP65 option for outdoor
5. To achieve rich lighting effects with external controller, such as jumping, fading, flashing etc.
6. Long lifespan with great lumen maintenance

Application

Signage, theaters, building facades, outline, landscape lighting etc.

Installation

Fix by 3M self adhesive tape

Specification

Model No.	Light Color	Color Temperature/ Wavelength(K/nm)	Beam Angle	Luminous Flux(lm/m)	Ra	Efficacy (lm/W)	Voltage (V DC)	Power (W/m)
DN-F5050A-60-12	R	620-625	120°	108	--	15	12	7.2
	G	515-530		338	--	47		7.2
	B	460-470		69	--	9.5		7.2
	WW	2700		783	80+	68		11.5
	R+G+B	10000		470	--	28		16.8

NOTE:Power is the total power of three RGB LEDs.

Other Parameters

Model No.	LED Quantity (pcs/m)	Product Size (mm)	Max Run Single Feed(m)	Min Cuttable length(mm)	Working Temperature	Storage Temperature
DN-F5050A-60-12	60	5000*14	2.5	50	-20~+60°C	-20~+70°C

NOTE:

Test environment temperature : 25±2°C.

The above data is typical values. The actual data of each single product may differ from the typical values. The data is subject to change without notice.

Different color temperature will make luminous flux different.

Single feed only. The max run length is related to the working current of the LED.

Profile Drawings

Unit:mm[inch]

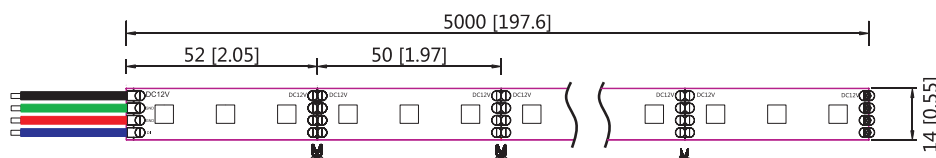

Note:For detail drawing,please consult sales rep.

Length vs. Power vs. Voltage Drop

Model No.	Working Length(m)	Rated Current(A)	Rated Voltage (DC V)	Rated Power(W)	Recommended Power Supply Configuration (W)	Power Supply Mode
DN-F5050A-60-12	1	1.4	12	16.8	20	Single feed
	2	2.8		33.5	40	Single feed
	2.5	3.5		40	50	Single feed
	3	4.2		50	65	Double feed
	4	5.6		67	85	Double feed
	5	7		80	100	Double feed

NOTE:

Test environment temperature : 25±2°C.

Recharge every 5 meters and long series connection can be achieved (only recharging at the positive and negative poles).

Luminous Intensity Distribution Diagram

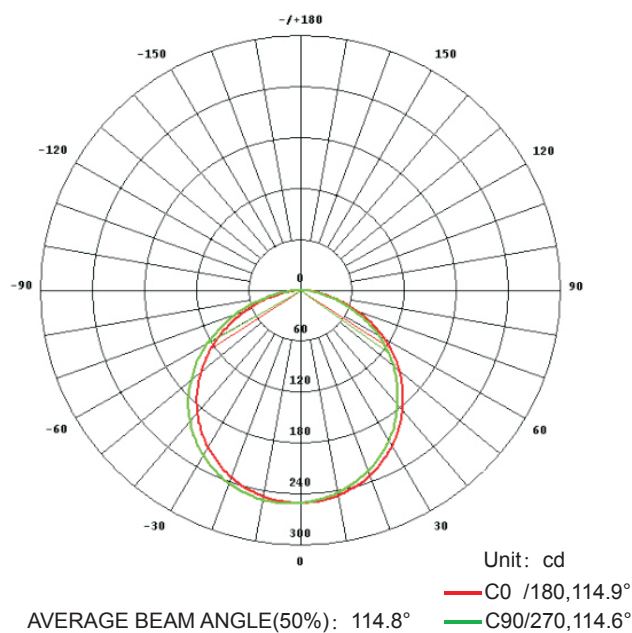

Average Illumination

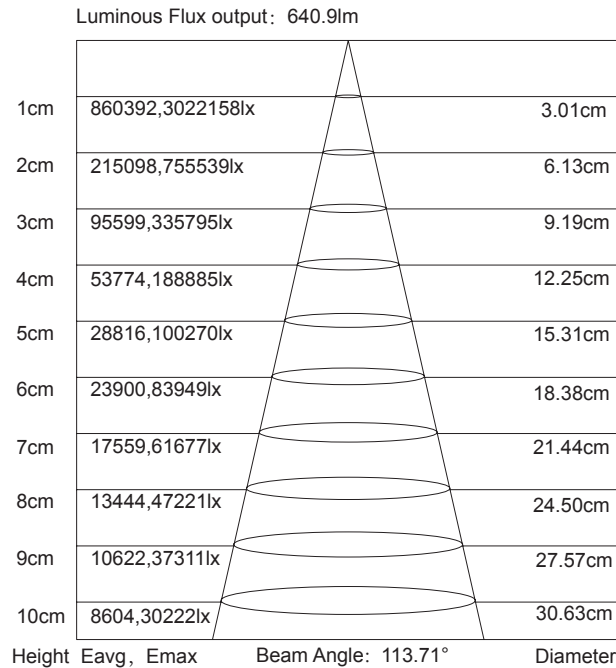

Note:

The above two figures are tested with the sample at CCT 2700K, for other light color or spec, please consult sales rep.

packing

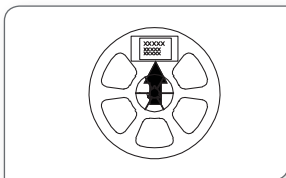

Label the reel;

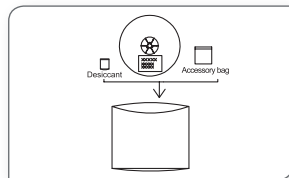

Put reel, accessory bag and desiccant together into static shielding bag;

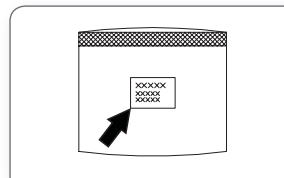

Seal and label the static shielding bag;

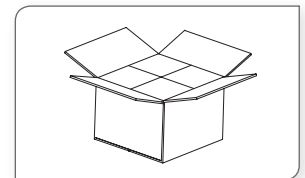

Put the packed static shielding bag into carton box;

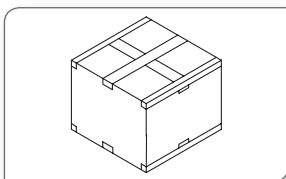

Seal the carton box;

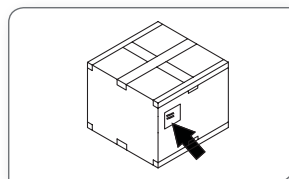

Label the box;

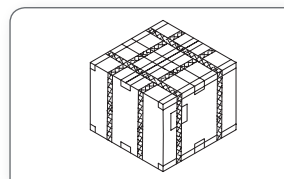

Use packing belt to pack. Add edge protectors if necessary.

Packaging information

Model No.	Product Size L*W(mm)	Carton Size(mm)	Meter/Reel	Reel/Carton	Net Weight(kg)	Gross Weight(kg)
DN-F5050A-60-12	5000X14	550X400X340	5	70	8.0(1±10%)	13.0(1±10%)

Note:

Five meters per reel, packed in the static shielding bag.

The above quantity and weight are only for the illustrated packaging method. There will be differences in the quantity and weight with other packaging methods.

Installation

1.Products and Tools



DN-F5050A

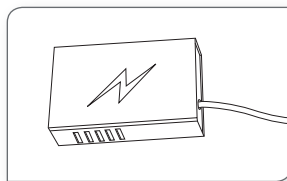

LED power supply

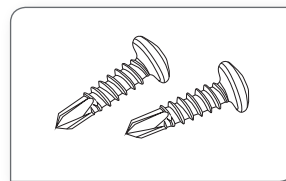

Self-tapping screw

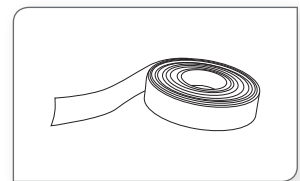

Insulation Tape

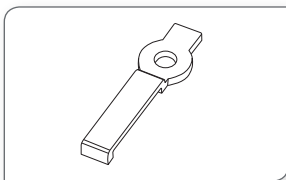

Clips

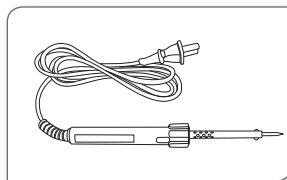

Electric iron

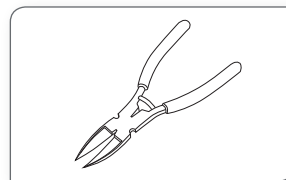

Diagonal pliers

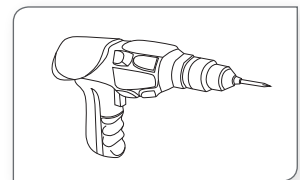

Electric drill

2.Installation Methods and Steps

Aluminum channel installation

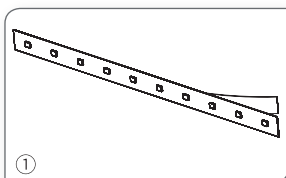

①

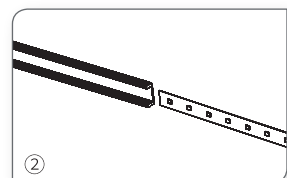

②

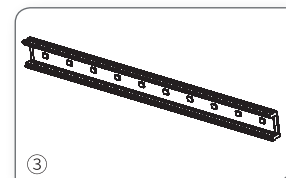

③

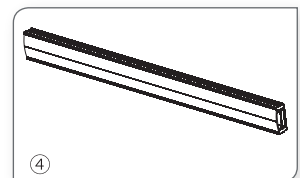

④

1. Peel away the self adhesive tape on the back of strip.
2. Cut off the excess part based on the installation position.
3. Evenly arrange the strips with appropriate space in the track.
4. Install the cover and end cap.

Covered channel installation

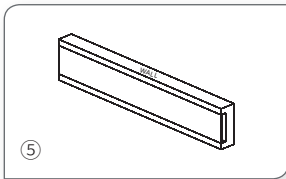
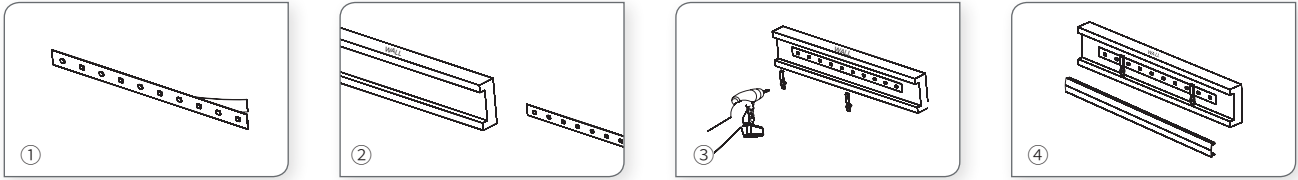

1. Peel away the self adhesive tape on the back of strip.
2. Cut off the excess part based on the installation position.
3. Evenly arrange the strips with appropriate space in the track and fix them with clips.
4. Install the cover and end cap.
6. Finished

3.Controller Wiring Diagram

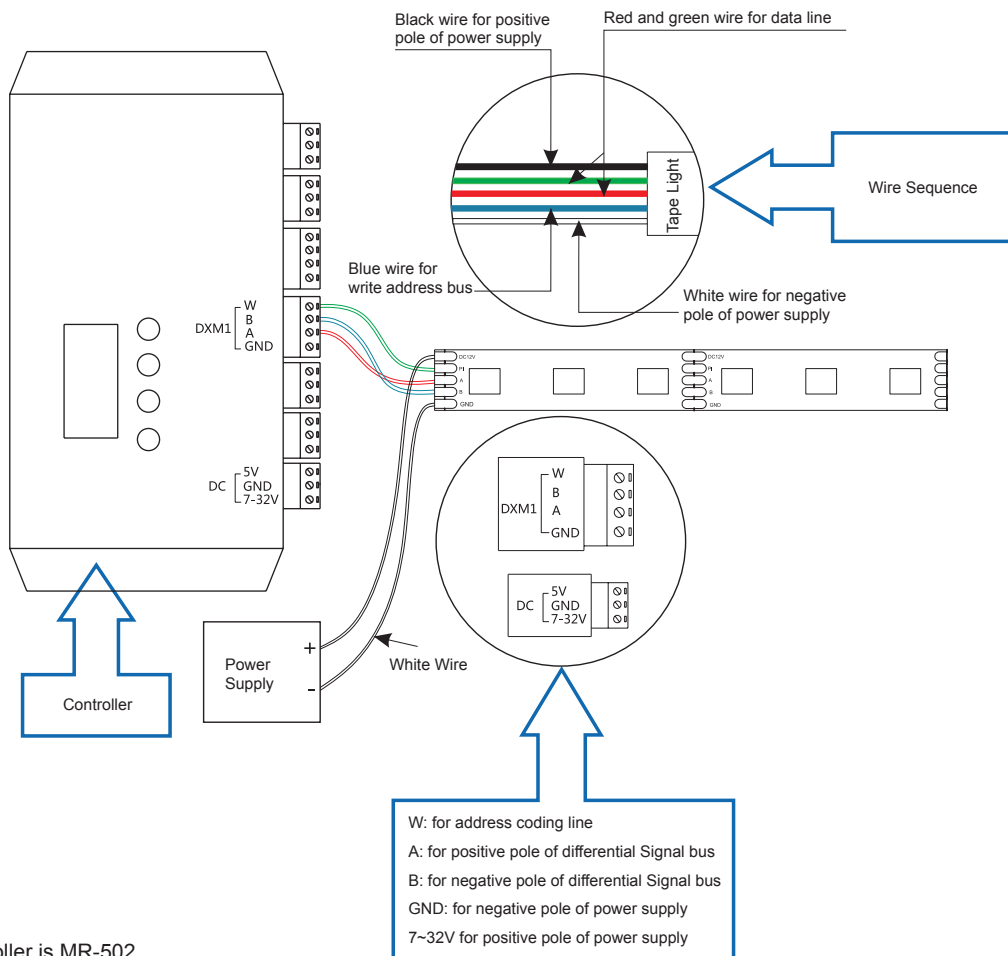

Note:

1. The controller is MR-502.
2. Single port of MR-502 can drive 512 pixels
3. The working voltage of the controller is DC 12V
4. This example chooses 12V product as an example, if it is 24V product, then choose 24V power supply;
5. For additional information, please refer to the MR-502 Instruction Manual.

Attentions before installation

- Before installation, check that the product parameters are consistent with the requirements (Seeing product specifications or product labels)
- Load voltage, current, power and power supply should be matched with the product.
- Follow the instructions of wiring diagram (first connect the load and then the power supply) to avoid short circuit.
- Make sure the correct connection of positive and negative poles between products and power supply. Otherwise, the light will not be on.
- Make sure the power cord firmly screwed into the terminal and it should not be pulled out by hands.
- The terminal should have insulation, waterproof and anti-corrosive treatment.
- If the working length exceeded the max run length, make sure to have extra power supply.
- If it needs higher current of a LED, make sure having extra cooling.

Common Faults and Troubleshoot

Quick Guide		
Problems	Reasons	Solutions
All LEDs can not light on.	No electric supply.	Power on
	Automatic power protection from the open or short circuit in output of the power supply.	Fix the short circuit problem.
	Wrong connection of power supply.	
	Without controller	Attach the appropriate controller, then power on
LEDs can not light on partly.	Some switching mode power supplies are not powered.	Check the power supply system to fix it.
	Power supply line error.	
	Mistaken wire connection of some of products	Correctly connection
Brightness of LED is inconsistent or insufficient.	Power overloaded.	Replace with more powerful power
	Power supply circuit excessive consumption.	Make sure the working voltage of the product within $\pm 5\%$ of standard voltage, or keep balance by circuit power consumption.
	Excessive quantities in series connection of the product	Reduce the quantities of the product in series connection to meet requirement.
LED flicker.	Connection point fault.	Remove bad connection point.
	Switching power supply failure.	Replace a new power supply.
	Wrong Installation or use of products	Please follow the instructions

Warning

- Do not disassemble or retrofit the light. Do not touch the surface of the light with a sharp object.
- Do not do live-line working during installation, especially for high voltage product.
- Do not use any organic chemical solvents.
- Use neutral glass adhesive to fix this product and it needs to be dried 4 hours in the open environment after operation.
- Treat the ends and the circuit connection points that are not connected to the main line with insulation, waterproof, and anti-corrosion in the installation.
- Use 18AWG (0.75mm² cross-sectional area) or thicker core wire to avoid adverse consequences caused by overheating, if the power cable need to lengthen.
- Make sure the input voltage meets the requirements and lines are connected correctly before lighting on.
- This product is for signage, and do not use as general lighting.
- Series connection within the max run.
- The length of the power cable between the power supply and the led strip should not exceed 2 meters. Otherwise, large circuit loss will lead to inconsistent brightness.
- Installation, maintenance and repair should be operated by a qualified technician.

Statements and Recycling

Statements:

Repair should be operated by a qualified technician, if the external circuit or main line of this product is damaged.
 The parameters given in this manual are typical values and for reference only.
 All illustrations and drawings in this manual are for reference.
 This product is subject to change without notice.

Recycling:

LED lighting products belongs to electronic products, please do recycling treatment according to the relevant WEEE directives.